



CAMRY Hybrid

Gasoline-Electric

Hybrid Synergy Drive

HYBRID VEHICLE DISMANTLING MANUAL

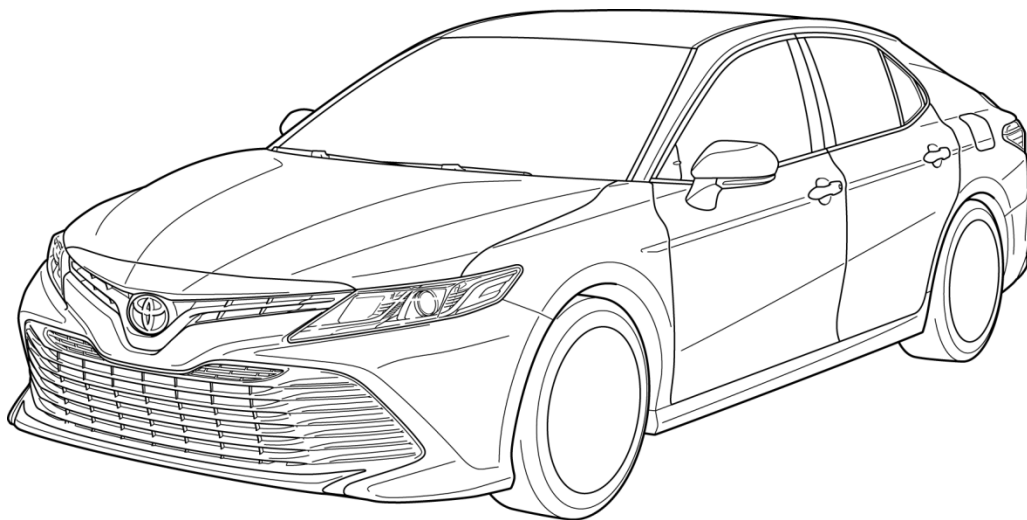

AXVH70/AXVH71 Series

Foreword

This guide was developed to educate and assist dismantlers in the safe handling of Toyota CAMRY Hybrid gasoline-electric hybrid vehicles. CAMRY Hybrid dismantling procedures are similar to other non-hybrid Toyota vehicles with the exception of the high voltage electrical system. It is important to recognize and understand the high voltage electrical system features and specifications of the Toyota CAMRY Hybrid, as they may not be familiar to dismantlers.

High voltage electricity powers the electric motor, generator, Air Conditioning (A/C) compressor and inverter/converter. All other automotive electrical devices such as the head lights, radio, and gauges are powered from a separate 12 Volt auxiliary battery. Numerous safeguards have been designed into the CAMRY Hybrid to help ensure the high voltage, approximately 244.8*1 or 259.0*2 Volt, Nickel Metal Hydride (NiMH) Hybrid Vehicle (HV) battery pack*1 or Lithium-ion (Li-ion) Hybrid Vehicle (HV) battery pack*2 is kept safe and secure in an accident.

The NiMH HV battery pack*1 or the Lithium-ion (Li-ion) HV battery pack*2 contains sealed batteries that are similar to rechargeable batteries used in some battery operated power tools and other consumer products. The electrolyte is absorbed in the cell plates and will not normally leak out even if the battery is cracked. In the unlikely event the electrolyte does leak, it can be easily neutralized with a dilute boric acid solution or vinegar.

High voltage cables, identifiable by orange insulation and connectors, are isolated from the metal chassis of the vehicle.

*1: for Nickel-Metal hydride battery

*2: for Lithium-ion battery

Additional topics contained in the guide include:

- Toyota CAMRY Hybrid identification.
- Major hybrid component locations and descriptions.

By following the information in this guide, dismantlers will be able to handle CAMRY Hybrid hybrid-electric vehicles as safely as the dismantling of a conventional gasoline engine automobile.

© 2021 Toyota Motor Corporation

All rights reserved. This book may not be reproduced or copied, in whole or in part, without the written permission of Toyota Motor Corporation.

Table of Contents

<u>About the CAMRY Hybrid</u>	<u>1</u>
<u>CAMRY Hybrid Identification</u>	<u>2</u>
<u>Exterior</u>	<u>4</u>
<u>Interior</u>	<u>5</u>
<u>Engine Compartment</u>	<u>6</u>
<u>Hybrid Component Locations & Descriptions</u>	<u>7</u>
<u>Specifications</u>	<u>9</u>
<u>Hybrid Synergy Drive Operation</u>	<u>10</u>
<u>Vehicle Operation</u>	<u>10</u>
<u>Hybrid Vehicle (HV) Battery Pack and Auxiliary Battery</u>	<u>11</u>
<u>HV Battery Pack</u>	<u>11</u>
<u>Components Powered by the HV Battery Pack</u>	<u>12</u>
<u>HV Battery Pack Recycling</u>	<u>12</u>
<u>Auxiliary Battery</u>	<u>12</u>
<u>High Voltage Safety</u>	<u>13</u>
<u>High Voltage Safety System</u>	<u>13</u>
<u>Service Plug Grip</u>	<u>14</u>
<u>Precaution to be observed when dismantling the vehicle</u>	<u>15</u>
<u>Necessary Items</u>	<u>16</u>
<u>Spills</u>	<u>17</u>
<u>Dismantling a vehicle</u>	<u>19</u>
<u>Removal of HV battery</u>	<u>25</u>

About the CAMRY Hybrid

The CAMRY Hybrid 4-door sedan joins the hybrid model for Toyota.

Hybrid Synergy Drive means that the vehicle contains a gasoline engine and an electric motor for power. The two hybrid power sources are stored on board the vehicle:

1. Gasoline stored in the fuel tank for the gasoline engine.
2. Electricity stored in a high voltage Hybrid Vehicle (HV) battery pack for the electric motor.

The result of combining these two power sources is improved fuel economy and reduced emissions. The gasoline engine also powers an electric generator to recharge the battery pack; unlike a pure all electric vehicle, the CAMRY Hybrid never needs to be recharged from an external electric power source.

Depending on the driving conditions one or both sources are used to power the vehicle. The following illustration demonstrates how the CAMRY Hybrid operates in various driving modes.

- ❶ During light acceleration at low speeds, the vehicle is powered by the electric motor. The gasoline engine is shut off.
- ❷ During normal driving, the vehicle is powered mainly by the gasoline engine. The gasoline engine also powers the generator to recharge the battery pack and to drive the motor.
- ❸ During full acceleration, such as climbing a hill, both the gasoline engine and the electric motor power the vehicle.
- ❹ During deceleration, such as when braking, the vehicle regenerates kinetic energy from the front wheels to produce electricity that recharges the battery pack.
- ❺ While the vehicle is stopped, the gasoline engine and electric motor are off, however the vehicle remains on and operational.

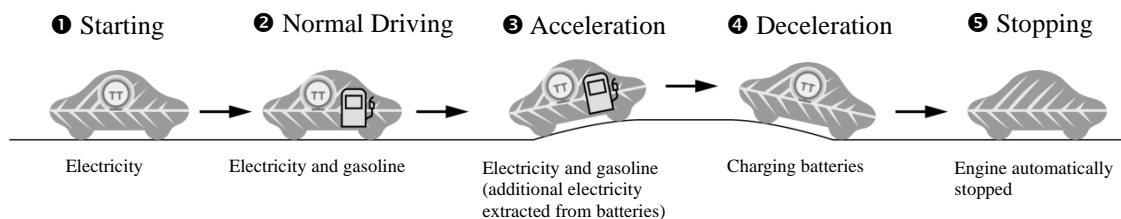

CAMRY Hybrid Identification

In appearance, the CAMRY Hybrid is nearly identical to the conventional, non-hybrid Toyota CAMRY. The CAMRY Hybrid is a 4-door sedan. Exterior, interior, and engine compartment illustrations are provided to assist in identification.

The alphanumeric 15 character Vehicle Identification Number (VIN) is provided in the left side windshield cowl and under the right side front seat and on the left side or right side B pillar.

Example VIN:

4T1B <u>3</u> 1HK 0000000
①

A CAMRY Hybrid is identified by the 5th alphanumeric character of the VIN.

①	Engine Series	Battery Type	Production Base
3	A25A-FXS	Lithium-ion battery	TMMK
2	A25A-FXS	Nickel-Metal hydride battery	TMMK TMC
7	A25B-FXS	Nickel-Metal hydride battery	TKM
5	A25A-FXS	Nickel-Metal hydride battery	TMT
T	A25B-FXS	Nickel-Metal hydride battery	GTMC
A	A25A-FXS	Lithium-ion battery	TMC
D	A25D-FXS	Nickel-Metal hydride battery	GTMC

for GTMC

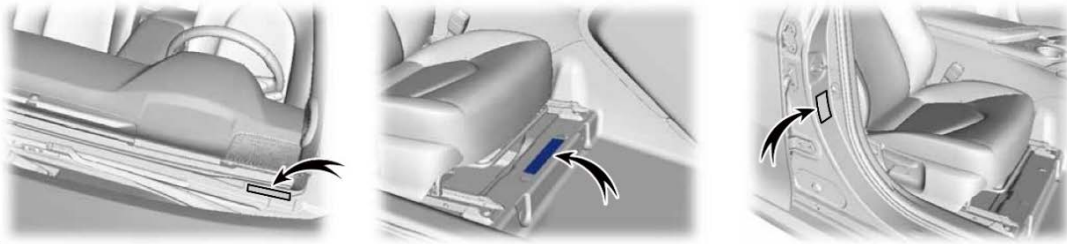

H

Left Side Windshield Cowl, Under the Right Side Front Seat and Right Side B Pillar

for TMMK



H

Left Side Windshield Cowl and Left Side B Pillar

for TMC

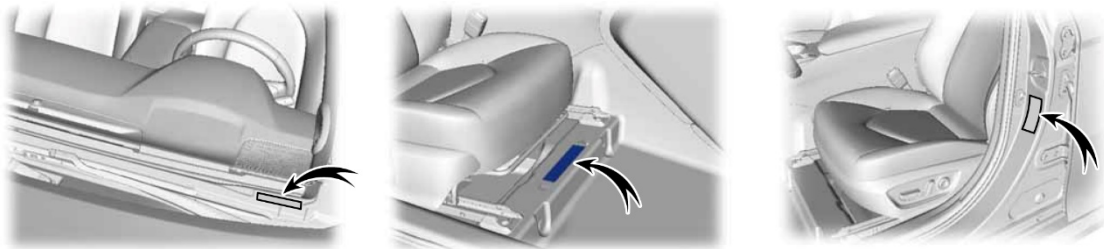

Left Side Windshield Cowl, Under the Right Side Front Seat and Left Side B Pillar

for TMT, TKM



Under the Right Side Front Seat and Left Side B Pillar

Exterior

- ❶ **HYBRID** logo on the back door and each front fender.
- ❷ Gasoline fuel filler door located on the left side rear quarter panel.

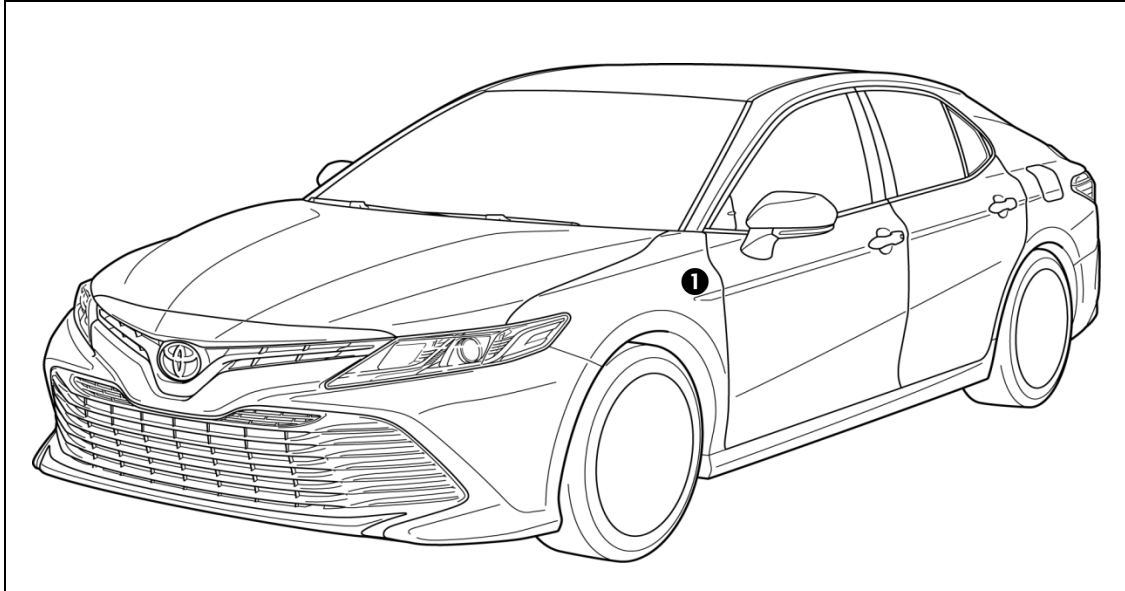

Exterior Front and Left Side View

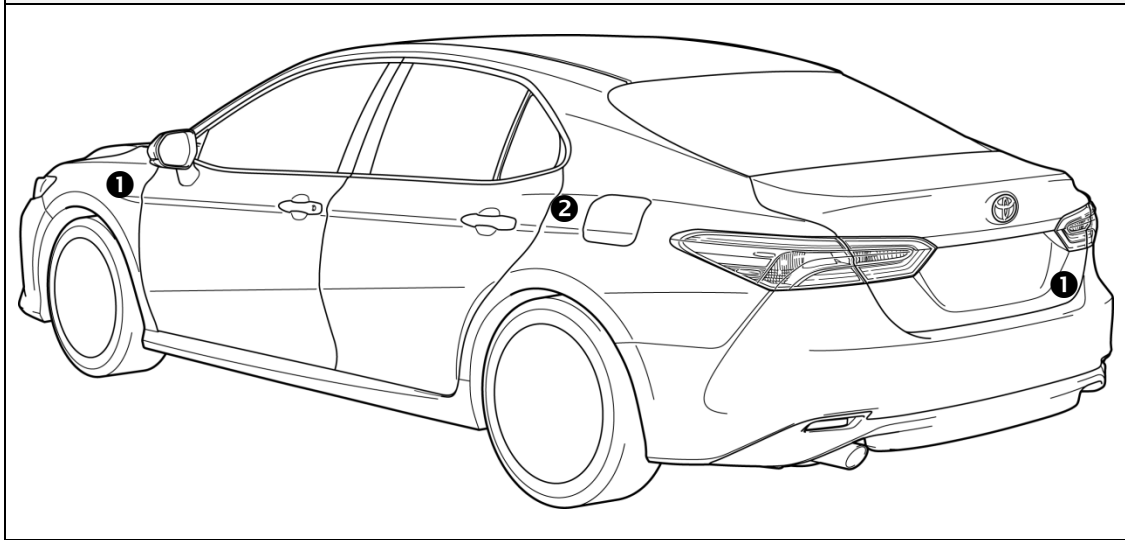

Exterior Rear and Left Side View

Interior

- ③ The instrument cluster (hybrid system indicator, **READY** indicator, and warning lights) located in the dash behind the steering wheel, is different than the one on the conventional, non-hybrid CAMRY.
- ④ In place of a tachometer, a hybrid system indicator is used to show power output.

Notice:

If the vehicle is shut off, the instrument cluster gauges will be “blacked out”, not illuminated.

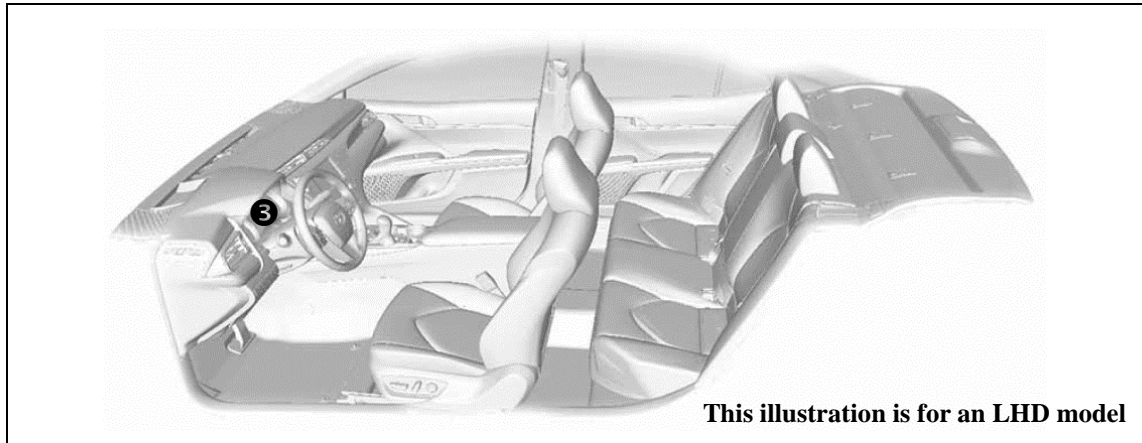

Interior View

③ for 4.2 Inch Multi-information Display

for 7 Inch Multi-information Display

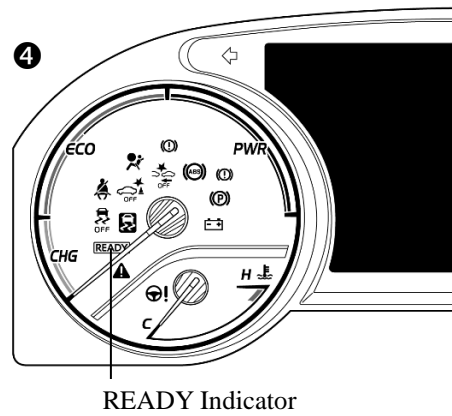
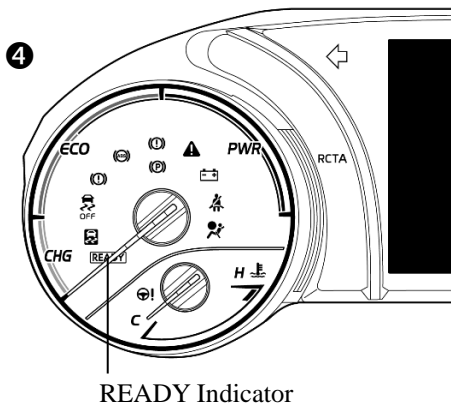

for 12.3 Inch Multi-information Display

Analog Display

Digital Display

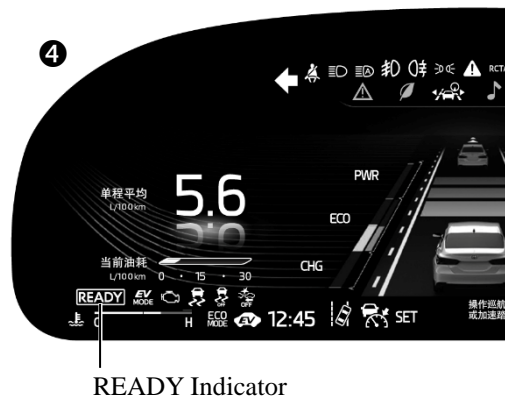

Combination Meter View

Engine Compartment

- ⑤ 2.5-liter aluminum alloy gasoline engine.
- ⑥ Orange colored high voltage power cables.

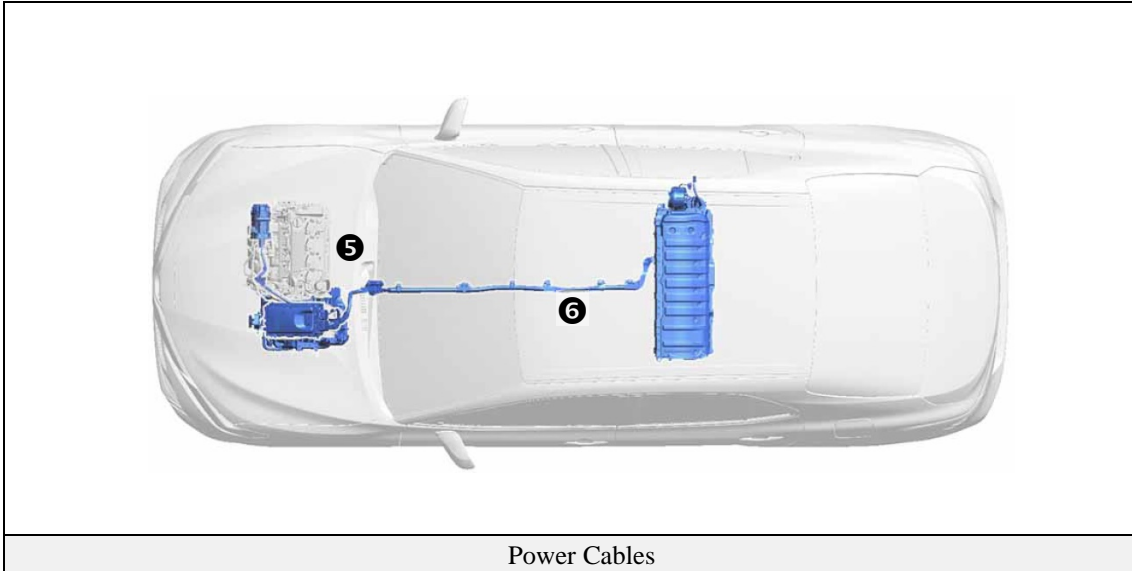

Hybrid Component Locations & Descriptions

Component	Location	Description
12 Volt Auxiliary Battery ❶	Luggage Compartment	Supplies electricity to the electrical components.
Hybrid Vehicle (HV) Battery Pack ❷	Cabin Area, Mounted Under Rear Seat	<ul style="list-style-type: none"> · Supplies electrical power to MG1 and MG2 in accordance with the driving conditions of the vehicle. · Recharged by MG1 and MG2 in accordance with the SOC and the driving conditions of the vehicle.
Power Cables ❸	Undercarriage and Engine Compartment	Connects the HV battery, inverter with converter assembly, hybrid vehicle transaxle assembly and compressor with motor assembly.
Inverter/ Converter ❹	Engine Compartment	<ul style="list-style-type: none"> · Converts the direct current from the boost converter into alternating current for MG1 and MG2, and vice versa (from AC to DC). · Boosts the HV battery nominal voltage of DC 244.8 V*1 / DC 259.0 V*2 up to a maximum voltage of DC 650 V and vice versa (steps down DC 650 V to DC 244.8 V*1 / DC 259.0 V*2).
Gasoline Engine ❺	Engine Compartment	Provides two functions: 1) Powers vehicle. 2) Powers generator to recharge the HV battery pack. The engine is started and stopped under control of the vehicle computer.
Electric Motor ❻	Engine Compartment	<ul style="list-style-type: none"> · MG2, which is driven by electrical power from MG1 and the HV battery, generates motive force for the drive wheels. · During braking, or when the accelerator pedal is not depressed, it generates high-voltage electricity to recharge the HV battery.

Component	Location	Description
Electric Generator ⑦	Engine Compartment	MG1, which is driven by the engine, generates high-voltage electricity in order to operate MG2 and charge the HV battery. Also, it functions as a starter to start the engine.
A/C Compressor (with Inverter) ③	Engine Compartment	3-phase high voltage AC electrically driven motor compressor.
DC-DC Converter for 12 Volt Auxiliary Battery ⑨	Engine Compartment	Steps down the HV battery nominal voltage of DC 244.8 V*1 / DC 259.0 V*2 to approximately DC 14 V in order to supply electricity to the electrical components, as well as to recharge the auxiliary battery.
Fuel Tank and Fuel Line ⑩	Undercarriage and Center	The fuel tank provides gasoline via a fuel line to the engine. The fuel line is routed under the center of vehicle.

*Numbers in the component column apply to the illustrations on the following page.

*1: for Nickel-Metal hydride battery

*2: for Lithium-ion battery

Specifications

Gasoline Engine: 131 kW, 2.5-liter Aluminum Alloy Engine
Electric Motor: 88 kW, Permanent Magnet Motor
Transmission: Automatic Only
HV Battery: 244.8 Volt Sealed NiMH-Battery*1
259.0 Volt Sealed Li-ion-Battery*2
Curb Weight: 3,480 – 3,737 lbs / 1,575 – 1,695 kg
Fuel Tank: 49.3 liters / 13.0 Us. gals / 10.8 Imp. Gals
50.0 liters / 13.2 Us. gals / 11.0 Imp. Gals
Frame Material: Steel Unibody
Body Material: Steel Panels
Seating Capacity: 5 passenger

*1: for Nickel-Metal hydride battery

*2: for Lithium-ion battery

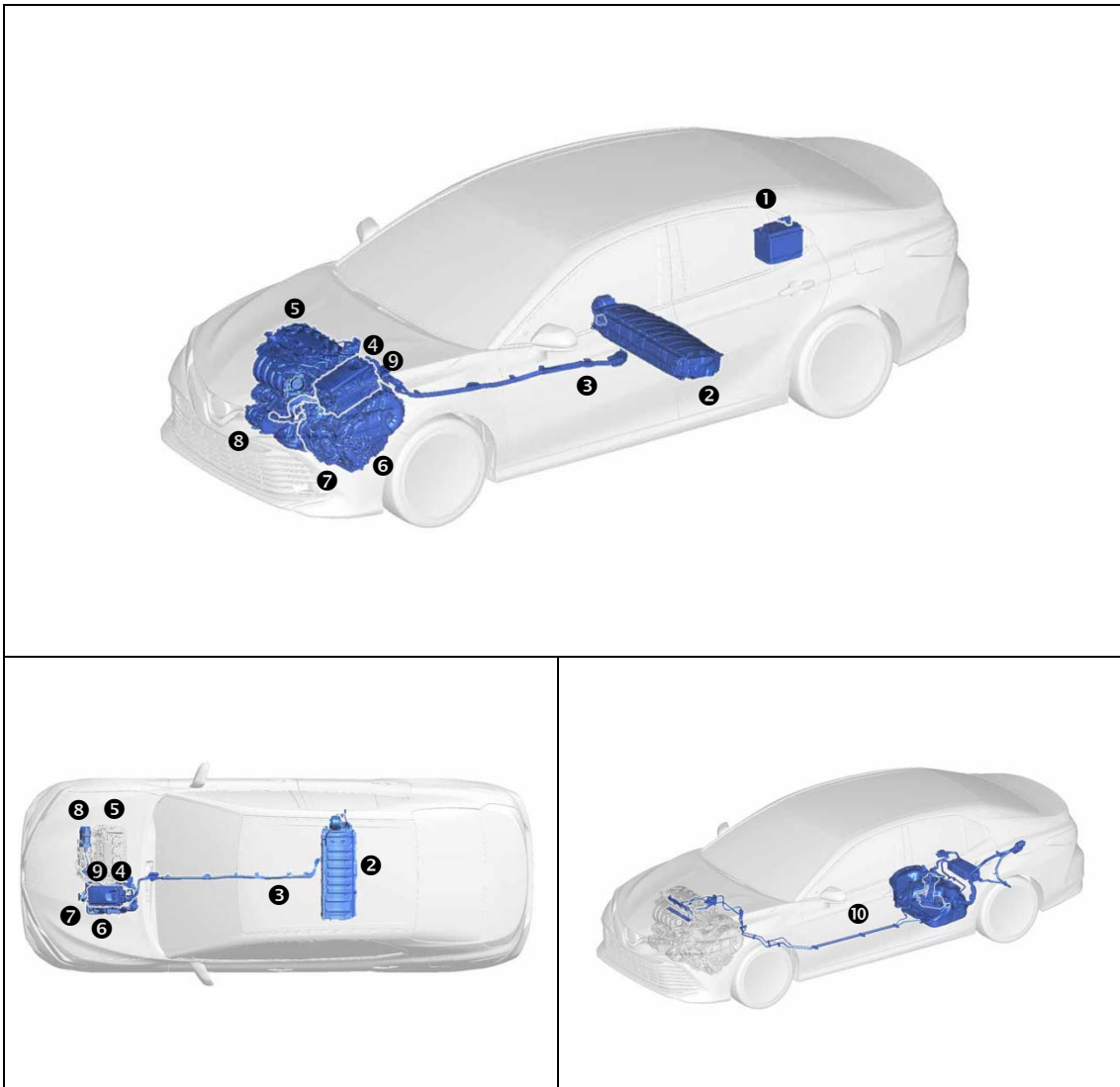

Hybrid Synergy Drive Operation

Once the **READY** indicator is illuminated in the instrument cluster, the vehicle may be driven. However, the gasoline engine does not idle like a typical automobile and will start and stop automatically. It is important to recognize and understand the **READY** indicator provided in the instrument cluster. When illuminated, it informs the driver that the vehicle is on and operational even though the gasoline engine may be off and the engine compartment is silent.

Vehicle Operation

- With the CAMRY Hybrid, the gasoline engine may stop and start at any time while the **READY** indicator is on.
- Never assume that the vehicle is shut off just because the engine is off. Always look for the **READY** indicator status. The vehicle is shut off when the **READY** indicator is off.

The vehicle may be powered by:

1. The electric motor only.
2. A combination of both the electric motor and the gasoline engine.

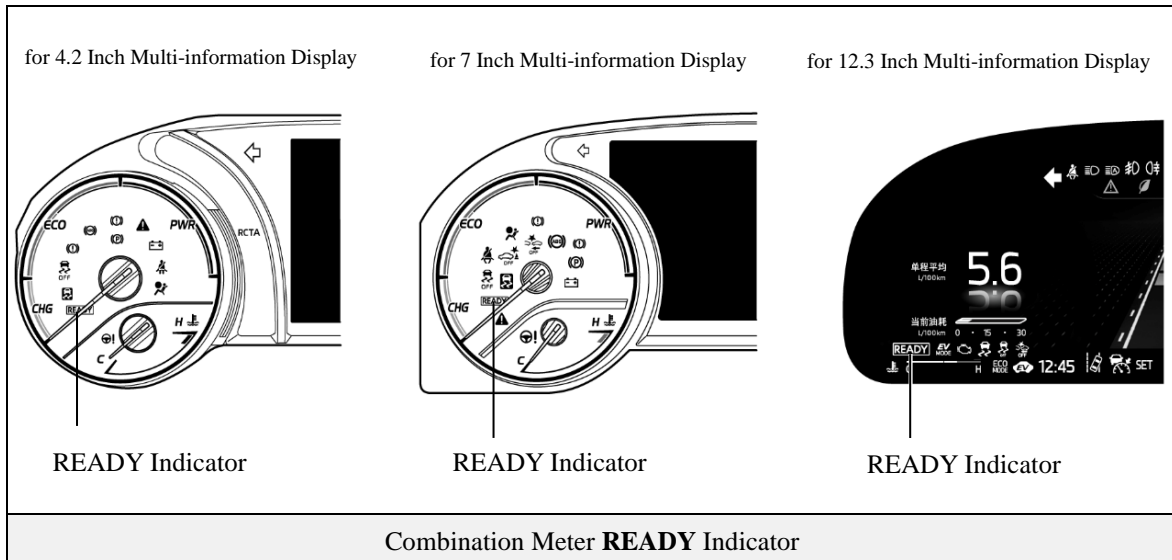

Hybrid Vehicle (HV) Battery Pack and Auxiliary Battery

The CAMRY Hybrid features a high voltage Hybrid Vehicle (HV) battery pack that contains sealed Nickel Metal Hydride (NiMH) battery modules*1 or Lithium-ion (Li-ion) battery cells*2.

*1: for Nickel-Metal hydride battery

*2: for Lithium-ion battery

HV Battery Pack

for Nickel-Metal hydride battery:

- The HV battery pack is enclosed in a metal case and is rigidly mounted to the cabin area under the rear seat. The metal case is isolated from high voltage and concealed by carpet in the cabin area.
- The HV battery pack consists of 34 low voltage (7.2 Volt) NiMH battery modules connected in series to produce approximately 244.8 Volts. Each NiMH battery module is non-spillable and sealed in a metal case.
- The electrolyte used in the NiMH battery module is an alkaline mixture of potassium and sodium hydroxide. The electrolyte is absorbed into the battery cell plates and will not normally leak, even in a collision.

HV Battery Pack	
Battery pack voltage	244.8 V
Number of NiMH battery modules in the pack	34
NiMH battery module voltage	7.2 V

for Lithium-ion battery:

- The HV battery pack is enclosed in a metal case and is rigidly mounted to the cabin area under the right side front seat. The metal case is isolated from high voltage and concealed by fabric covers in the cabin area.
- The HV battery pack consists of 70 low voltage (3.7 Volt) Li-ion battery cells connected in series to produce approximately 259.0 Volts. Each Li-ion battery cell is non-spillable and in a sealed case.
- The electrolyte used in the Li-ion battery cells is a flammable organic electrolyte. The electrolyte is absorbed into the battery cell separator and will not normally leak, even in a collision.

HV Battery Pack	
Battery pack voltage	259.0 V
Number of Li-ion battery cells in the pack	70
Li-ion battery cell voltage	3.7 V

Components Powered by the HV Battery Pack





- Electric Motor
- Power Cables
- Electric Generator
- DC-DC Converter for 12 Volt Auxiliary Battery
- Inverter/Converter
- A/C Compressor

HV Battery Pack Recycling

- The HV battery pack is recyclable. Contact either your Toyota distributor as mentioned on HV Battery Caution Label or the nearest Toyota dealer.

Auxiliary Battery

- The CAMRY Hybrid contains a sealed lead-acid 12 Volt battery. This 12 Volt auxiliary battery powers the vehicle electrical system similar to a conventional vehicle. As with other conventional vehicles, the negative terminal of the auxiliary battery is grounded to the metal chassis of the vehicle.
- The auxiliary battery is located in the engine compartment area. It is concealed by a plastic cover on the left side in the battery compartment.

<p>for Nickel-Metal hydride battery:</p>  <p>for Lithium-ion battery:</p> 	 <p style="text-align: center;">Auxiliary Battery</p>
<p>244.8*1 / 259.0*2 Volt HV Battery Pack</p>	<p>12 Volt Auxiliary Battery Mounted in Luggage Compartment Area (Right Side)</p>
<p>for Nickel-Metal hydride battery:</p> 	<p>for Lithium-ion battery:</p> 
<p style="text-align: center;">HV Battery Pack Mounted in Cabin Area</p>	

*1: for Nickel-Metal hydride battery

*2: for Lithium-ion battery

High Voltage Safety

The HV battery pack powers the high voltage electrical system with DC electricity. Positive and negative orange colored high voltage power cables are routed from the battery pack, under the vehicle floor pan, to the inverter/converter. The inverter/converter contains a circuit that boosts the HV battery voltage from 244.8*1, 259.0*2 to 650 Volts DC. The inverter/converter creates 3-phase AC to power the motor. Power cables are routed from the inverter/converter to each high voltage motor (electric motor, electric generator, and A/C compressor). The following systems are intended to help keep occupants in the vehicle and emergency responders safe from high voltage electricity:

*1: for Nickel-Metal hydride battery

*2: for Lithium-ion battery

High Voltage Safety System

- A high voltage fuse ❶* provides short circuit protection in the HV battery pack.
- Positive and negative high voltage power cables ❷* connected to the HV battery pack are controlled by 12 Volt normally open relays ❸*. When the vehicle is shut off, the relays stop electrical flow from leaving the HV battery pack.



WARNING:

- ***The high voltage system may remain powered for up to 10 minutes after the vehicle is shut off or disabled. To prevent serious injury or death from severe burns or electric shock, avoid touching, cutting, or breaching any orange high voltage power cable or high voltage component.***

- Both positive and negative power cables ❷* are insulated from the metal body. High voltage electricity flows through these cables and not through the metal vehicle body. The metal vehicle body is safe to touch because it is insulated from the high voltage components.
- A ground fault monitor in the hybrid vehicle computer ❹* continuously monitors for high voltage leakage to the metal chassis while the vehicle is running. If a malfunction is detected, the hybrid vehicle computer ❹* will illuminate the master warning light  in the instrument cluster and a message indicating that the hybrid system is malfunctioning will be displayed on the multi-information display.
- The HV battery pack relays will automatically open to stop electrical flow in a collision sufficient to activate the SRS.

*Numbers apply to the illustration on the following page.

Service Plug Grip

- The high-voltage circuit is cut by removing the service plug grip (see page 19).

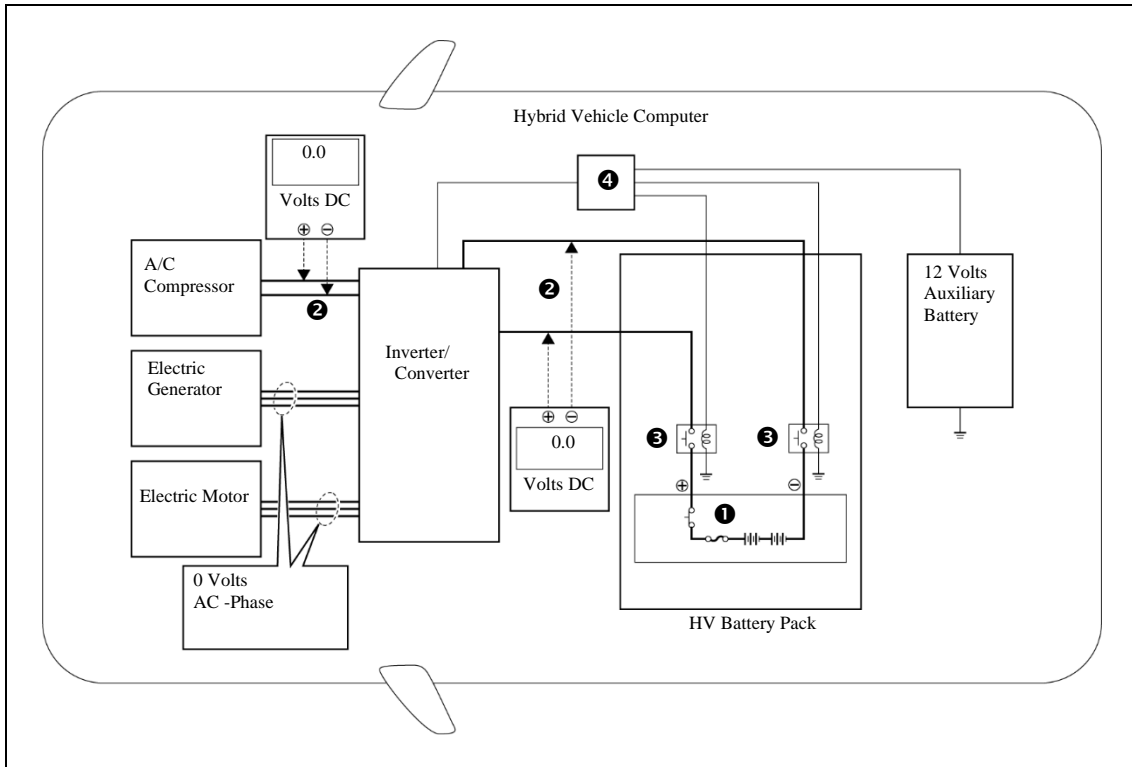

High Voltage Safety System – Vehicle Shut Off (**READY-OFF**)

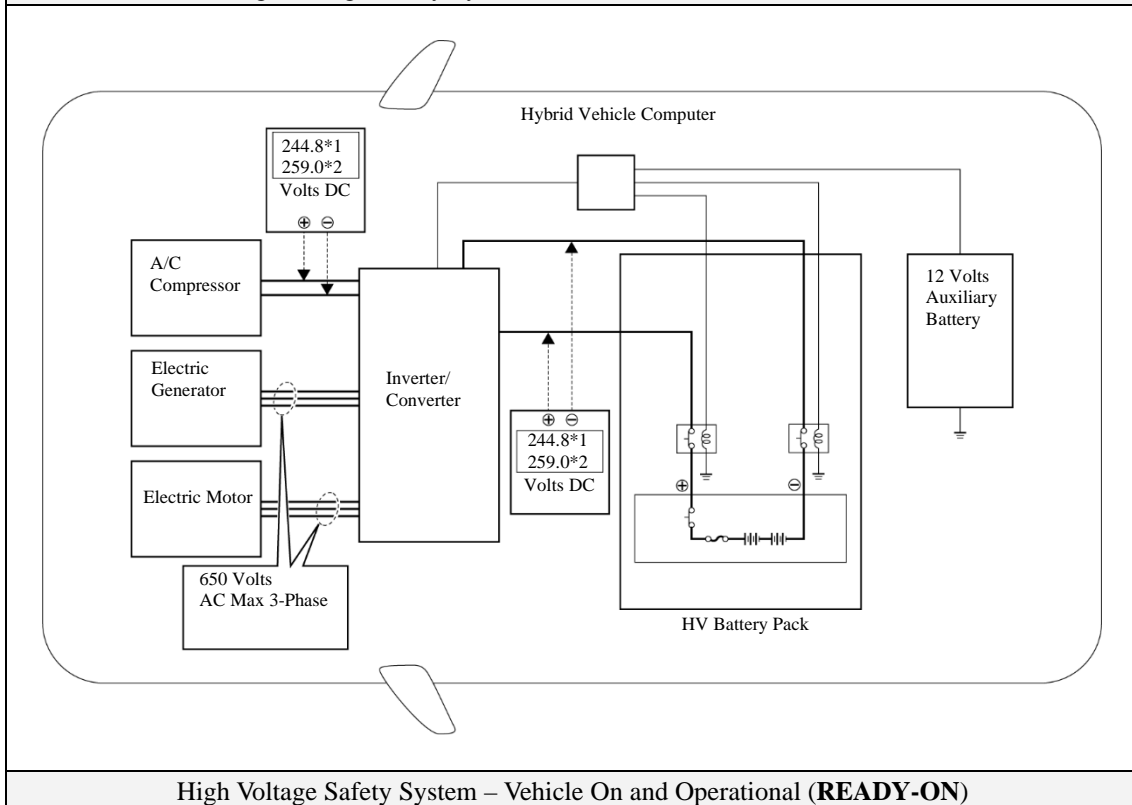

High Voltage Safety System – Vehicle On and Operational (**READY-ON**)

*1: for Nickel-Metal hydride battery

*2: for Lithium-ion battery

Precaution to be observed when dismantling the vehicle

- To prevent electric shock, wear insulated gloves when working on wire harnesses and components of the high voltage system.
Before using insulated gloves, be sure to check them for cracks, tears and other types of damage.
- When servicing the vehicle, do not carry metal objects like mechanical pencils or rulers that can be dropped accidentally and cause a short circuit.
- To reduce the risk of electric shock, make sure to remove the service plug grip to cut off the high voltage circuit before servicing the vehicle.
- To reduce the risk of electric shock, make sure to wait at least 10 minutes after removing the service plug grip to fully discharge the high voltage capacitor inside the inverter with converter assembly.
- Do not touch any high voltage wire harnesses, connectors or parts with bare hands.
- Do not touch the terminals of the service plug grip.
- Make sure to insulate the high-voltage connectors and terminals of the HV battery with insulating tape after removing them.
- After removing the service plug grip, put it in your pocket to prevent other technicians from accidentally reconnecting it while you are working on the high-voltage system.
- Before touching a bare high-voltage terminal, wear insulated gloves and use a tester to make sure that the terminal voltage is 0 V.
- If the vehicle catches on fire, use an ABC fire extinguisher to extinguish the fire.
Trying to extinguish a fire using only a small amount of water can be more dangerous than effective. Use a substantial amount of water or wait for firefighters.
- Do not allow any foreign matter or water to enter the HV battery.

for Nickel-Metal hydride battery:

- If the electrolyte comes in contact with your skin, use a saturated boric acid solution or a large amount of water to wash it off. If the electrolyte comes in contact with an article of clothing, take it off immediately.
- If the electrolyte comes in contact with your eyes, call out loudly for help. Do not rub your eyes. Wash them immediately with a large amount of water and seek medical care.
- If the electrolyte is swallowed, seek medical care immediately. Do not induce vomiting, unless instructed by the doctor.

for Lithium-ion battery:

- Electrolyte leaks may cause acute poisoning if a high concentration of the vapor from the electrolyte is inhaled. In case of inhalation, move the affected person to a place with ample fresh air and let them lie quietly. Seek medical care.
- If the electrolyte comes in contact with your skin, wash the area thoroughly with soap and plenty of water, and seek medical care. If the electrolyte comes in contact with an article of clothing, take it off immediately. Prolonged contact with the electrolyte may cause skin irritation.
- If the electrolyte comes in contact with your eyes, call out loudly for help. Do not rub your eyes. Immediately flush them with a large amount of water for at least 15 minutes and seek medical care.
- If electrolyte is swallowed, seek medical care immediately. Do not induce vomiting, unless instructed by the doctor.

Necessary Items

- Protective clothing such as insulated gloves (electrically insulated), rubber gloves, helmet, safety goggles, safety shoes and SCBA or protective mask.
- Insulating tape such as electrical tape that has a suitable electrical insulation rating and insulation tool set.
- An electrical tester that is capable of measuring DC 750 Volts or more.

Spills

for Nickel-Metal hydride battery:

The CAMRY Hybrid contains the same common automotive fluids used in other non-hybrid Toyota vehicles, with the exception of the NiMH electrolyte used in the HV battery pack. The NiMH battery electrolyte is a caustic alkaline (pH 13.5) that is damaging to human tissues. The electrolyte, however, is absorbed in the cell plates and will not normally spill or leak out even if a battery module is cracked. A catastrophic crash that would breach both the metal battery pack case and a metal battery module would be a rare occurrence.

A caustic alkaline is at the opposite end of the pH scale from a strong acid. A safe (neutral) substance is approximately in the middle of this scale. Adding a weak acidic mixture, such as a dilute boric acid solution or vinegar, to the caustic alkaline electrolyte will cause the electrolyte to be neutralized. This is similar but opposite to the use of baking soda to neutralize a lead-acid battery electrolyte spill.

A Toyota Product Safety Data Sheets (PSDS) is attached to this document.

- Handle NiMH electrolyte spills using the following Personal Protective Equipment (PPE):
 - Splash shield or safety goggles. Fold down helmet shields are not acceptable for acid or electrolyte spills.
 - Rubber, latex or nitrile gloves.
 - Apron suitable for alkaline.
 - Rubber boots.

- Neutralize NiMH electrolyte.
 - Use a boric acid solution or vinegar.
 - Boric acid solution - 800 grams boric acid to 20 liters water or 5.5 ounces boric acid to 1 gallon of water.

for Lithium-ion battery:

The CAMRY hybrid contains the same common automotive fluids used in other non-hybrid Toyota vehicles, with the exception of the Li-ion electrolyte used in the HV battery pack. The electrolyte used in the Li-ion battery cells is a flammable organic electrolyte. The electrolyte is absorbed into the battery cell separators, even if the battery cells are crushed or cracked, it is unlikely that liquid electrolyte will leak. Any liquid electrolyte that leaks from a Li-ion battery cell quickly evaporates.



WARNING:

- ***The Li-ion battery contains organic electrolyte. Only a small amount may leak from the batteries which may irritate the eyes, nose, throat, and skin.***
- ***Contact with the vapor produced by the electrolyte may irritate the nose and throat.***
- ***To avoid injury by coming in contact with the electrolyte or vapor, wear personal protective equipment for organic electrolyte including SCBA or protective mask for organic gases.***

- Handle Li-ion electrolyte spills using the following Personal Protective Equipment (PPE):
 - Splash shield or safety goggles. A fold down face shield is not acceptable for acid or electrolyte spills.
 - Rubber gloves or gloves suitable for organic solvents.
 - Apron suitable for organic solvents.
 - Rubber boots or boots suitable for organic solvents.
 - Protective mask for organic gases or SCBA.

Dismantling a vehicle

The following 6 pages contain general instructions for use when working on a CAMRY Hybrid.

Read these instructions before proceeding to the HV battery removal instructions on page 25.



WARNING:

- ***The high voltage system may remain powered for up to 10 minutes after the vehicle is shut off or disabled. To prevent serious injury or death from severe burns or electric shock, avoid touching, cutting, or breaching any orange high voltage power cable or any high voltage component.***

1. Remove Luggage Trim Service Hole Cover

- (1) Disengage the 2 claws and remove the luggage trim service hole cover.

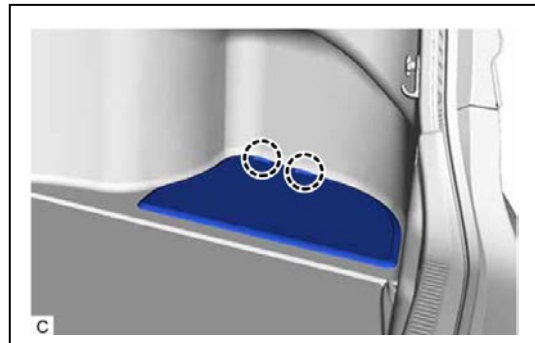

2. Disconnect Cable From Negative Auxiliary Battery Terminal

- (1) Loosen the nut, and disconnect the cable from the negative (-) auxiliary battery terminal.

Type A

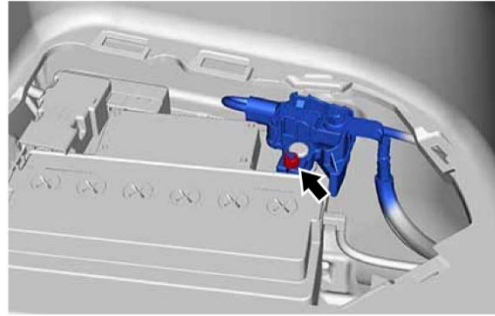

Type B

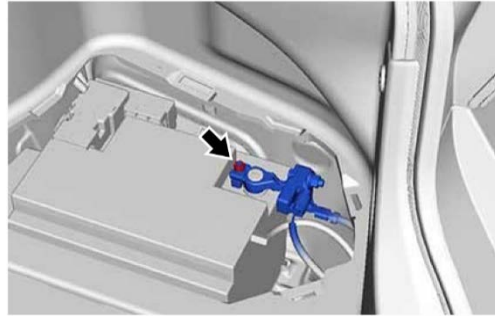

3. Remove Battery Service Hole Cover

- (1) Remove the clip.
- (2) Disengage the 7 claws as shown in the illustration.

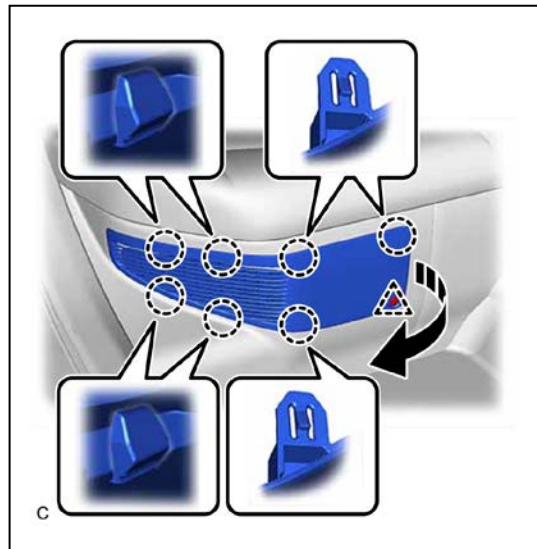

- (3) Disengage the guide to remove the battery service hole cover as shown in the illustration.

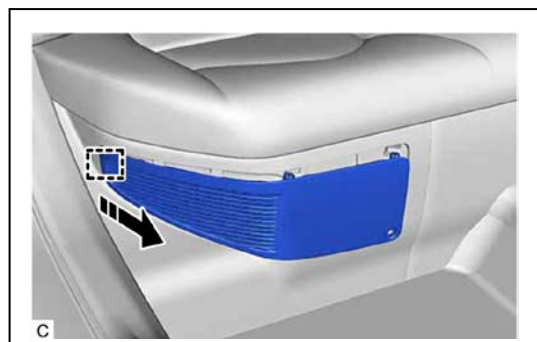

4. Remove Service Plug Grip

CAUTION:

- Be sure to wear insulated gloves.
- Do not inspect or service the high voltage system with the service plug grip installed.
- To reduce the risk of electric shock, make sure to remove the service plug grip to cut off the high voltage circuit before servicing the vehicle.
- To reduce the risk of electric shock, make sure to wait at least 10 minutes after removing the service plug grip to fully discharge the high voltage capacitor inside the inverter with converter assembly.
- Keep the removed service plug grip in your pocket to prevent other technicians from accidentally installing it while you are servicing the vehicle.

Notice:

- After removing the service plug grip, turning the power switch on (READY) may cause a malfunction. Do not turn the power switch on (READY) unless instructed by the repair manual.
- Do not touch the terminals of the service plug grip.

Hint:

Waiting for at least 10 minutes is required to discharge the high voltage capacitor inside the inverter with converter assembly.



- (1) While wearing insulated gloves, rotate the handle of the service plug grip and remove the service plug grip as indicated by the arrows, in the order shown in the illustration.

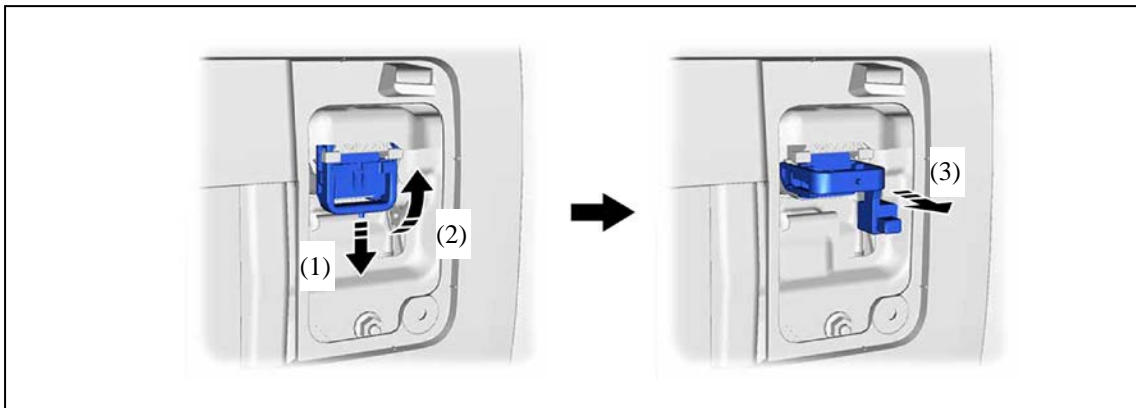

5. Make other staff aware that a high-voltage system is being dismantled by using the following sign: CAUTION: HIGH-VOLTAGE. DO NOT TOUCH (see page 24).

6. If the service plug grip cannot be removed due to damage to the vehicle, remove the **IG2-MAIN** fuse (20A).

Caution:

This operation shuts off the HV system. Be sure to wear insulated gloves because high voltage is not shut off inside the HV battery.

When it is possible to remove the

service plug grip, remove it and continue the procedure.

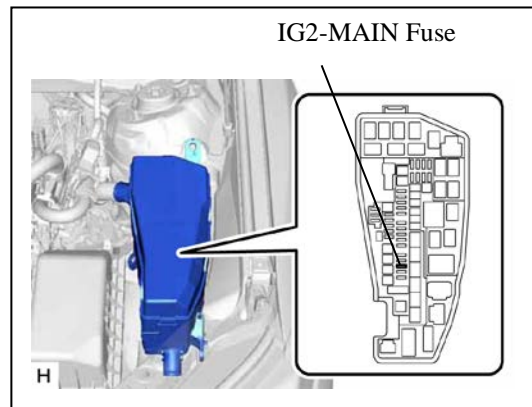

7. After disconnecting or exposing a high-voltage connector or terminal, insulate it immediately using insulating tape. Before touching a bare high-voltage terminal, wear insulated gloves.

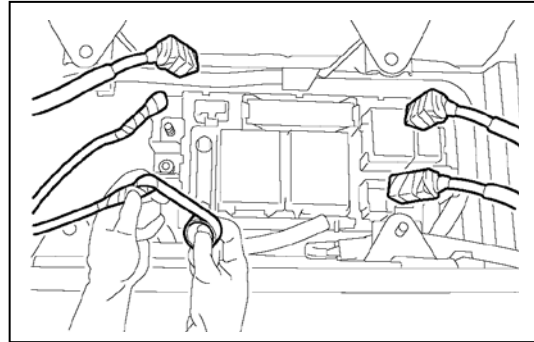

8. Check the HV battery and nearby area for leakage. If you find any liquid, it may be strong alkaline electrolyte. Wear rubber gloves and goggles and neutralize the liquid using a saturated boric acid solution or vinegar. Then wipe up the liquid using waste rags etc.

9. If the electrolyte comes into contact with your skin, wash the skin immediately using a saturated boric acid solution or a large amount of water. If the electrolyte adheres to any article of clothing, take the clothing off immediately.

10. If the electrolyte comes into contact with your eye(s), call out loudly for help. Do not rub your eye(s). Instead, wash the eye(s) with a dilute boric acid solution or a large amount of water and seek medical care.

11. With the exception of the HV battery, remove parts by following procedures which are similar to conventional Toyota vehicles. For the removal of the HV battery, refer to the following pages.

Person in charge: _____

CAUTION:
HIGH-VOLTAGE.
DO NOT TOUCH.

CAUTION:
HIGH-VOLTAGE.
DO NOT TOUCH.

Person in charge: _____

When performing work on the HV system, fold this sign and
put it on the roof of the vehicle.

Removal of HV battery



WARNING:

- *Be sure to wear insulated gloves when handling high-voltage parts.*
- *Even if the vehicle is shut off and the relays are off, be sure to remove the service plug grip before performing any further work.*
- *Power remains in the high voltage electrical system for 10 minutes even after the HV battery pack is shut off because the circuit has a condenser that stores power.*
- *Make sure that the tester reading is 0 V before touching any high-voltage terminals which are not insulated.*
- *The SRS may remain powered for up to 90 seconds after the vehicle is shut off or disabled. To prevent serious injury or death from unintentional SRS deployment, avoid cutting the SRS components.*

1. REMOVE LUGGAGE TRIM SERVICE HOLE COVER

- (1) Disengage the 2 claws and remove the luggage trim service hole cover.



2. DISCONNECT CABLE FROM NEGATIVE AUXILIARY BATTERY TERMINAL

- (1) Loosen the nut, and disconnect the cable from the negative (-) auxiliary battery terminal.

Type A

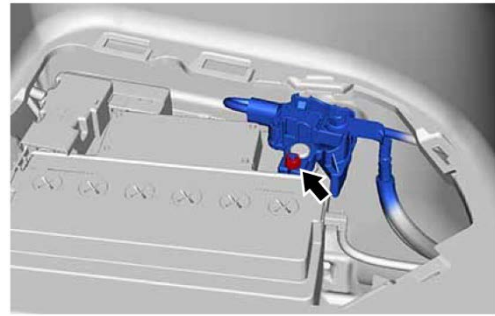

Type B

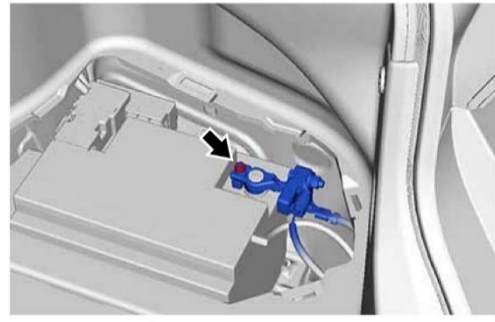

3. REMOVE BATTERY SERVICE HOLE COVER

- (1) Remove the clip.
- (2) Disengage the 7 claws as shown in the illustration.

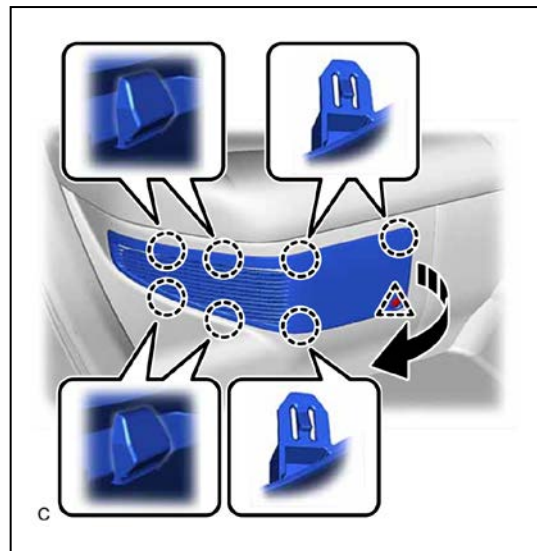

- (3) Disengage the guide to remove the battery service hole cover as shown in the illustration.

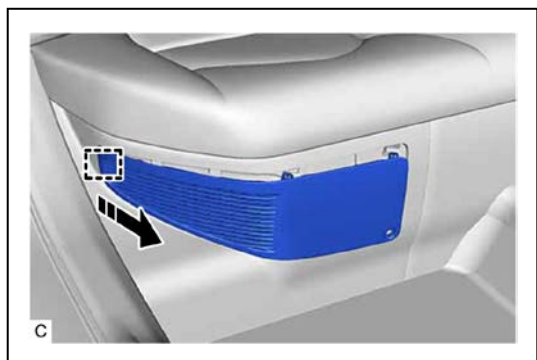

4. REMOVE SERVICE PLUG GRIP

CAUTION:

- Be sure to wear insulated gloves.
- Do not inspect or service the high voltage system with the service plug grip installed.
- To reduce the risk of electric shock, make sure to remove the service plug grip to cut off the high voltage circuit before servicing the vehicle.



- To reduce the risk of electric shock, make sure to wait at least 10 minutes after removing the service plug grip to fully discharge the high voltage capacitor inside the inverter with converter assembly.
- Keep the removed service plug grip in your pocket to prevent other technicians from accidentally installing it while you are servicing the vehicle.



Notice:

- After removing the service plug grip, turning the power switch on (READY) may cause a malfunction. Do not turn the power switch on (READY) unless instructed by the repair manual.
- Do not touch the terminals of the service plug grip.

Hint:

Waiting for at least 10 minutes is required to discharge the high voltage capacitor inside the inverter with converter assembly.

- (1) While wearing insulated gloves, rotate the handle of the service plug grip and remove the service plug grip as indicated by the arrows, in the order shown in the illustration.

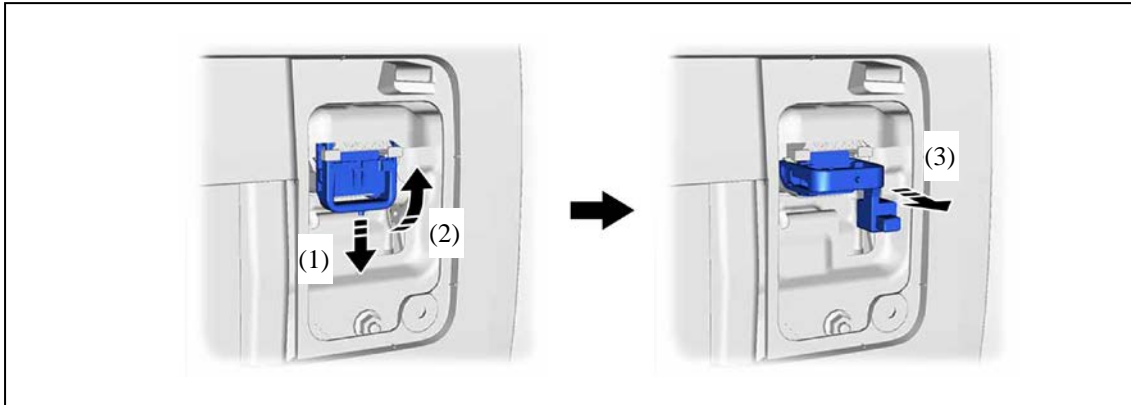

5. DISCONNECT ENGINE ROOM MAIN WIRE

Caution:

Be sure to wear insulated gloves.

Notice:

Do not allow any foreign matter or water to enter the inverter with converter assembly.

- (1) Move the lock lever while pushing the lock on the connector, and disconnect the inverter with converter assembly connector.

Notice:

- Do not damage the terminals, connector housing or inverter with converter assembly during disconnection.
- Cover the hole where the cable was connected with tape (non-residue type) or equivalent to prevent entry of foreign matter.
- Insulate the disconnected terminals with insulating tape.
- Do not touch the waterproof seal or terminals of the connector.

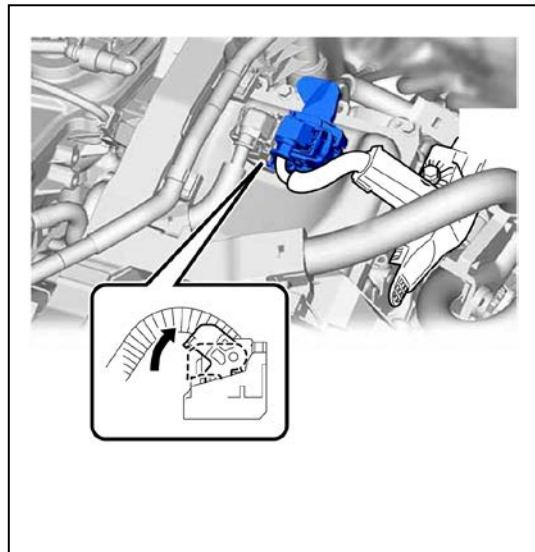

6. REMOVE CONNECTOR COVER ASSEMBLY

Caution:

Be sure to wear insulated gloves.

- (1) Remove the bolt (B).
- (2) Using a T25 "TORX" socket wrench, remove the bolt (A) and connector cover assembly from the inverter with converter assembly.

Notice:

- Do not touch the connector cover assembly waterproof seal.
- Do not allow any foreign matter or water to enter the inverter with converter assembly.

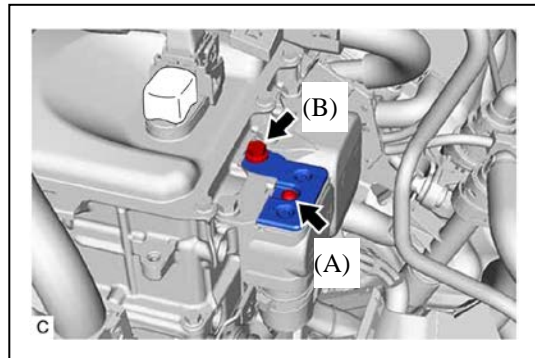

7. CHECK TERMINAL VOLTAGE

Caution:

Be sure to wear insulated gloves.

- (1) Using a voltmeter, measure the voltage between the terminals of the 2 phase connectors.

Standard voltage:

0 V

Notice:

Do not allow any foreign matter or water to enter the inverter with converter assembly.

Hint:

Use a measuring range of DC 750 V or more on the voltmeter.

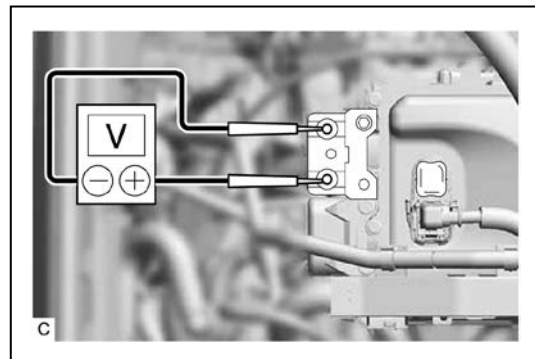

8. CUT REAR CENTER SEAT OUTER BELT ASSEMBLY

- (1) Cut the rear center seat outer belt assembly.

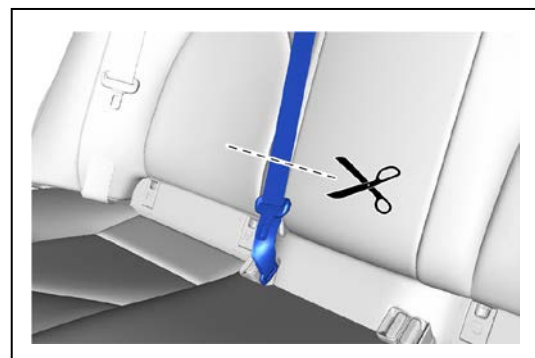

9. REMOVE REAR SEAT CUSHION ASSEMBLY

- (1) Lift the front edge of the rear seat cushion assembly as shown in the illustration and disengage the 2 rear seat cushion frame hooks on the front side of the rear seat cushion assembly from the rear seat cushion lock hooks.

Notice:

Be sure to hold the parts of the rear seat cushion assembly directly next to the rear seat cushion frame hooks when lifting it. Lifting a different part of the cushion may deform the rear seat cushion frame.

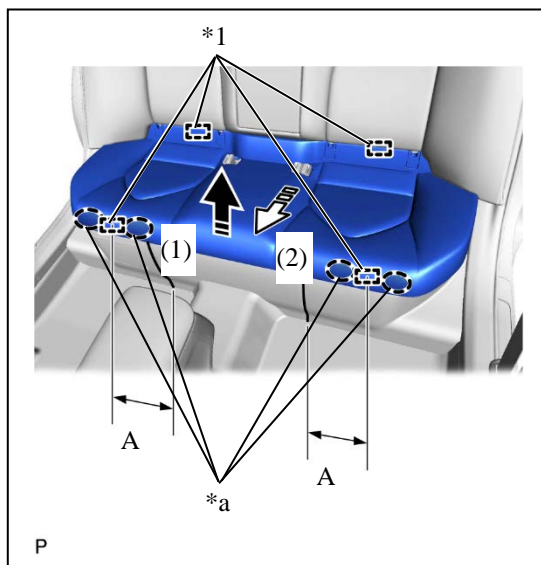

*1	Rear Seat Cushion Frame Hook
*a	Place Hands Here

Standard Measurement:

Area	Measurement
A	135 mm (5.31 in.)

- (2) Disengage the 2 rear seat cushion frame hooks on the rear side of the rear seat cushion assembly as shown in the illustration and remove the rear seat cushion assembly.

Notice:

Be careful not to damage the vehicle body.

10. REMOVE REAR SEAT CUSHION LOCK HOOK

- (1) Disengage the 2 claws to remove the rear seat cushion lock hook as shown in the illustration.

Hint:

Use the same procedure for the RH side and LH side.

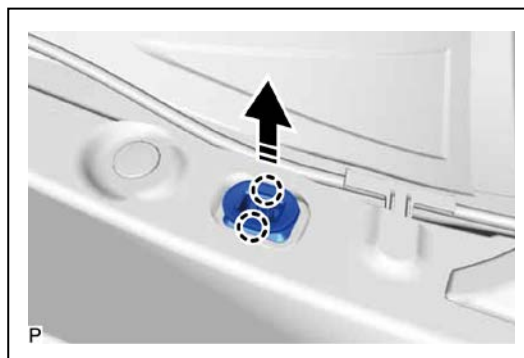

11. REMOVE REAR DOOR SCUFF PLATE LH

- (1) Disengage the claw as shown in the illustration.

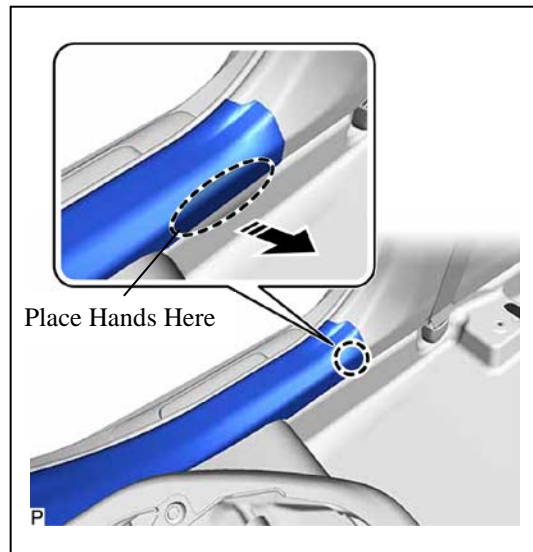

- (2) Disengage the 5 claws, clip and guide to remove the rear door scuff plate LH as shown in the illustration.

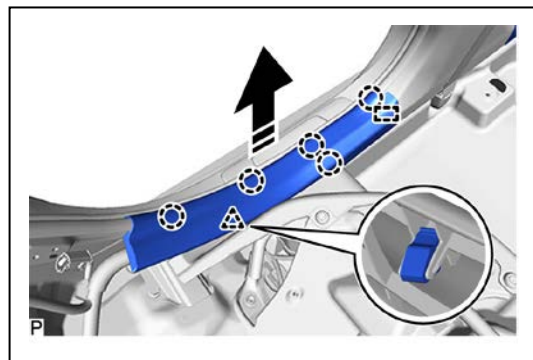

12. REMOVE REAR UNDER SIDE COVER LH

- (1) Remove the 2 crips (A).
- (2) Disengage the claw, 3 clips (B), 2 clips (C) and guide to remove the rear under side cover LH.

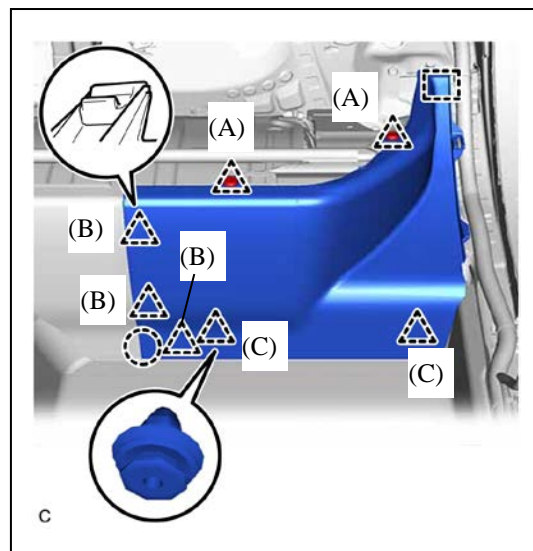

13. REMOVE REAR DOOR SCUFF PLATE RH

Hint:

Use the same procedure for the LH side.

14. REMOVE REAR UNDER SIDE COVER RH

- (1) Remove the 2 clips (A).
- (2) Disengage the claw, 3 clips (B), 2 clips (C) and guide to remove the rear under side cover RH.

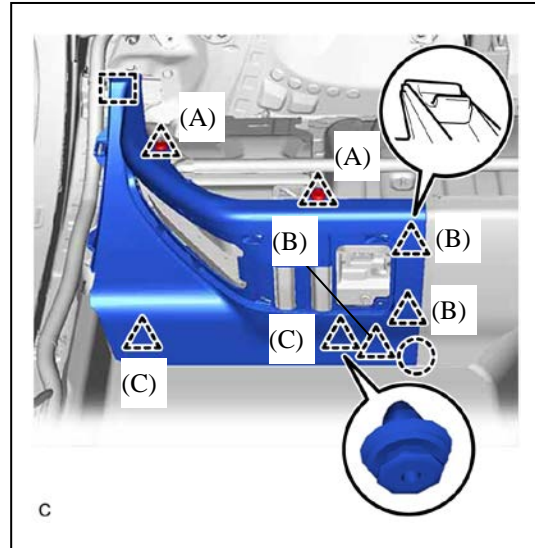

15. REMOVE REAR UNDER COVER

- (1) Pull the rear under cover in the direction indicated by the arrow (1) shown in the illustration to disengage the 2 clips.
- (2) Pull the rear under cover in the direction indicated by the arrow (2) shown in the illustration to disengage the 2 guides to remove it from the rear seat cushion leg sub-assembly.

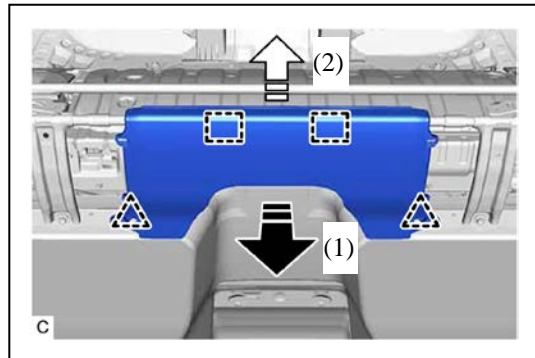

16. REMOVE REAR SEAT CUSHION LEG SUB-ASSEMBLY

- (1) Remove the 6 bolts and rear seat cushion leg sub-assembly.

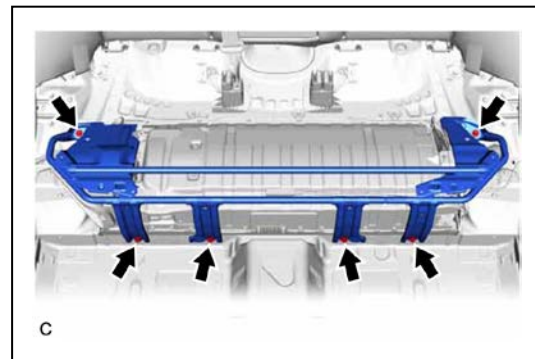

17. REMOVE NO. 1 HYBRID BATTERY INTAKE DUCTY

- (1) Disengage the 2 clamps.

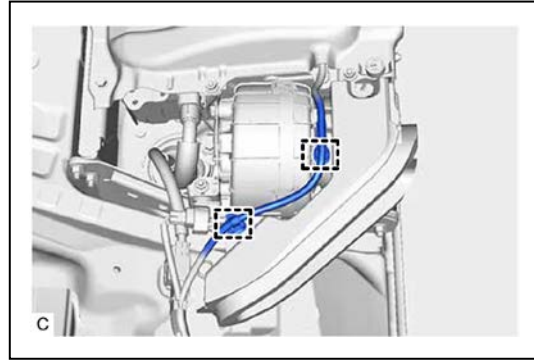

- (2) Remove the 2 clips and No. 1 hybrid battery intake duct from the battery cooling blower assembly.

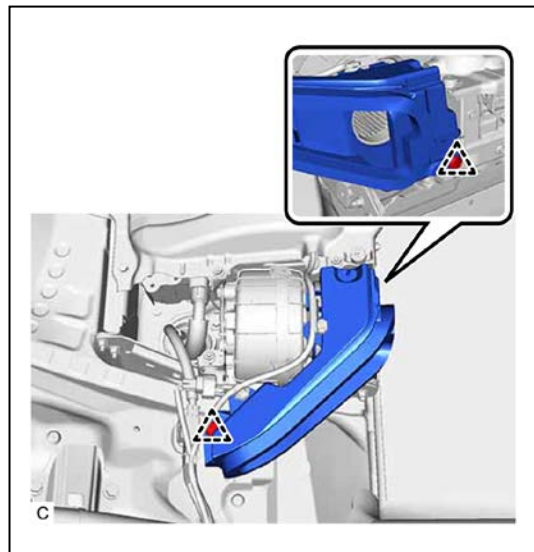

18. REMOVE BATTERY COOLING BLOWER ASSEMBLY

- (1) Disconnect the battery cooling blower assembly connector.

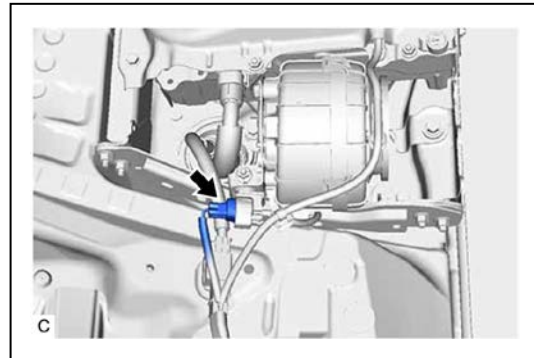

- (2) Remove the bolt, nut and battery cooling blower assembly from the HV battery.

Notice:

- Be sure not to touch the fan part of the battery cooling blower assembly.
- Do not lift the battery cooling blower assembly using the wire harness.

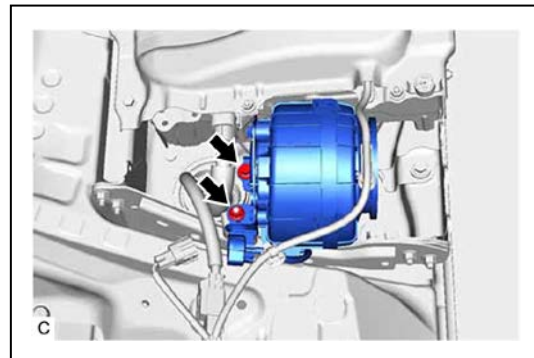

19. REMOVE NO. 1 HV BATTERY COVER PANEL RH

Caution:

Be sure to wear insulated gloves.

- (1) Using the service plug grip, remove the battery cover lock striker.

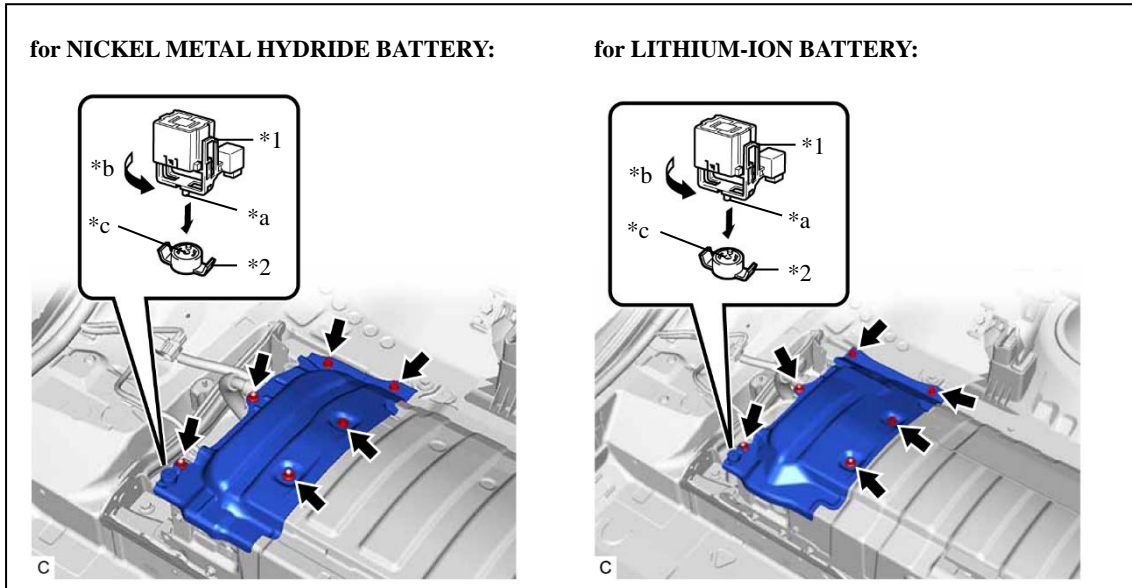

*1	Service Plug Grip	*2	Battery Cover Lock Striker
*a	Projection	*b	Turn
*c	Button	-	-

Hint:

Insert the projection of the service plug grip and turn the button of the battery cover lock striker counterclockwise to release the lock.

- (2) Remove the 3 bolts, 3 nuts and No. 1 HV battery cover panel RH from the HV battery.

20. DISCONNECT HV FLOOR UNDER WIRE

Caution:

Be sure to wear insulated gloves.

- (1) Disconnect the 2 HV battery junction block assembly connectors.

for NICKEL METAL HYDRIDE BATTERY:

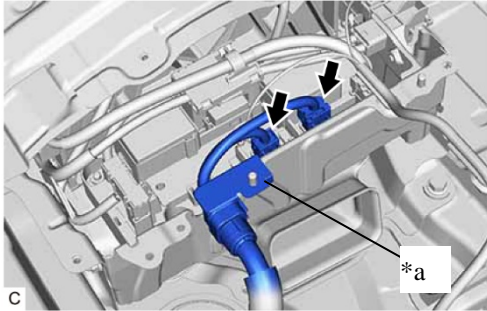

for LITHIUM-ION BATTERY:

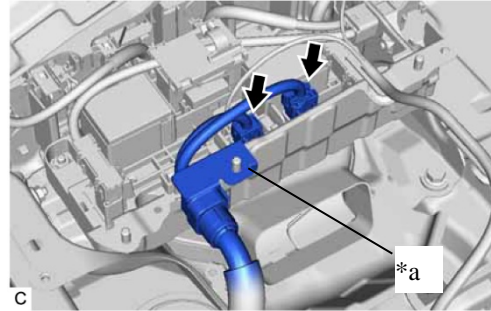

*a	Shield Ground	-	-
----	---------------	---	---

Notice:

Insulate each disconnected high-voltage connector with insulating tape. Wrap the connector from the wire harness side to the end of the connector.

- (2) Disconnect the shield ground from the HV battery.
- (3) Disconnect the floor wire connector.

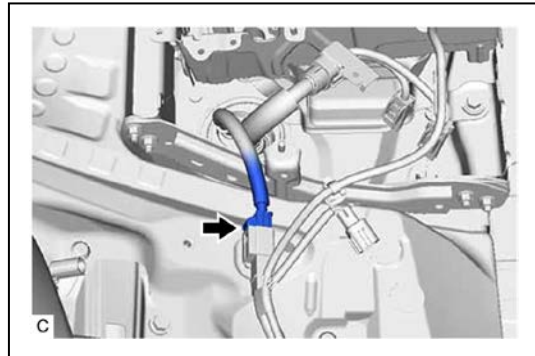

21. DISCONNECT FLOOR WIRE

Caution:

Be sure to wear insulated gloves.

- (1) Disengage the clamp.

for NICKEL METAL HYDRIDE BATTERY:

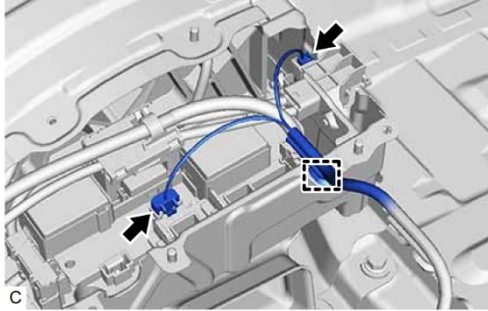

for LITHIUM-ION BATTERY:

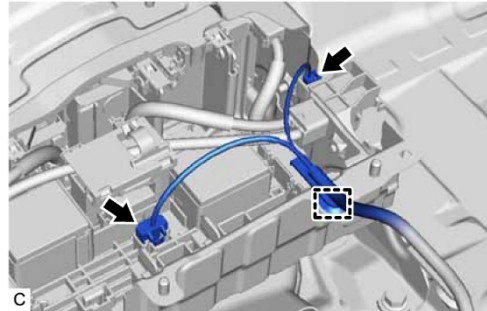

- (2) Disconnect the electric vehicle battery plug assembly connector.
- (3) Disconnect the HV battery junction block assembly connector.

22. REMOVE HYBRID BATTERY HOSE ASSEMBLY (for LITHIUM-ION BATTERY)

- (1) Disconnect the hybrid battery hose assembly from the vehicle.
- (2) Disengage the 2 claws to remove the hybrid battery hose assembly from the HV battery.

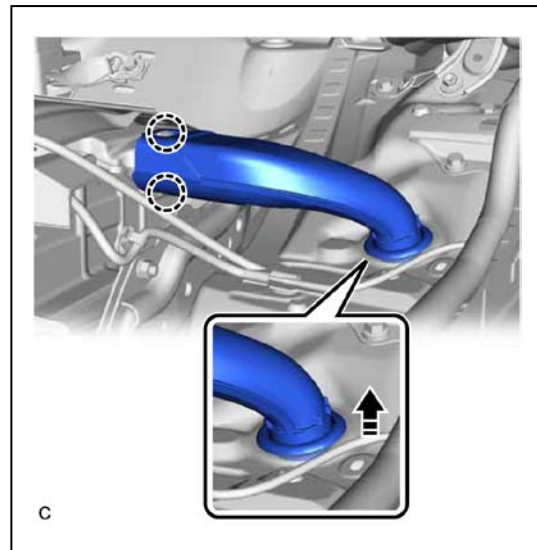

23. REMOVE INDOOR ELECTRICAL KEY ANTENNA ASSEMBLY

- (1) Disconnect the connector.
- (2) Disengage the clamp to remove the indoor electrical key antenna assembly.

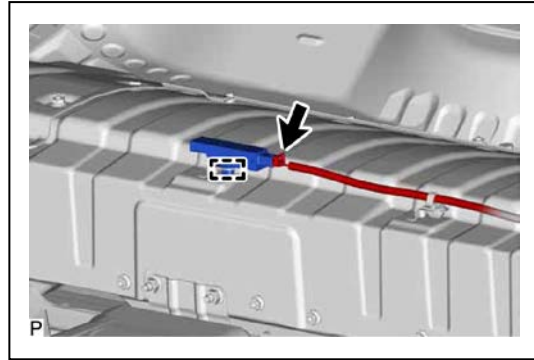

24. DISCONNECT FLOOR WIRE

Caution:

Be sure to wear insulated gloves.

- (1) for NICKEL METAL HYDRIDE BATTERY:
 - a) Disengage the 2 clamps to disconnect the floor wire.

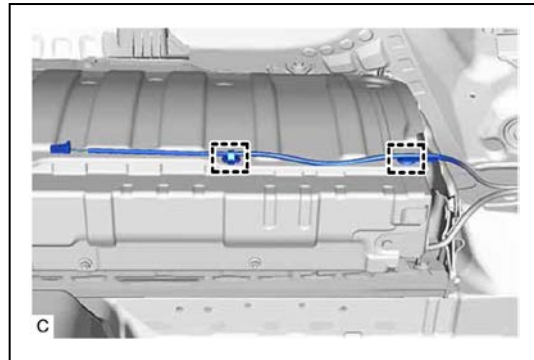

- (2) for LITHIUM-ION BATTERY:
 - a) Disengage the 2 clamps.

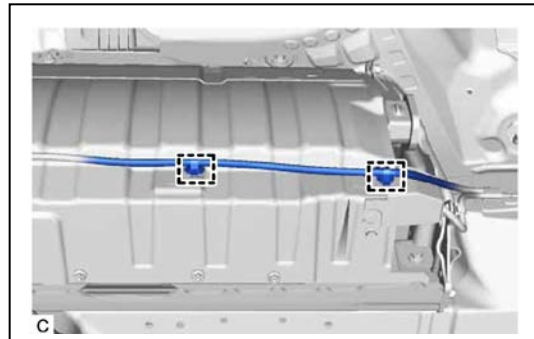

25. REMOVE NO. 1 HYBRID BATTERY EXHAUST DUCT (for Nickel Metal Hydride Battery)

Caution:

Be sure to wear insulated gloves.

- (1) Remove the clip.
- (2) Disengage the claw to remove the No. 1 hybrid battery exhaust duct from the HV battery.

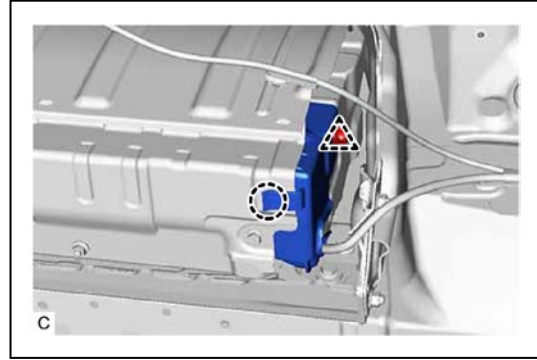

26. REMOVE NO. 4 HV BATTERY PROTECTOR (for LITHIUM-ION BATTERY)

Caution:

Be sure to wear insulated gloves.

- (1) Disengage the clamp to remove the No. 4 HV battery protector from the HV battery.

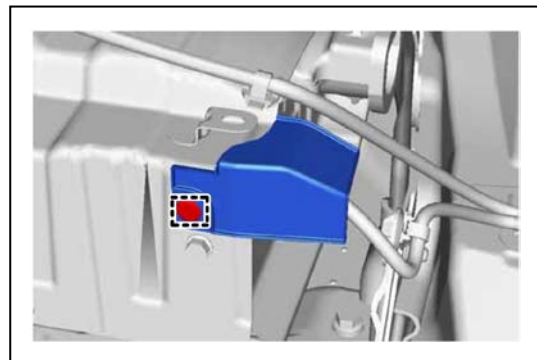

27. DISCONNECT FLOOR WIRE

Caution:

Be sure to wear insulated gloves.

- (1) for NICKEL METAL HYDRIDE BATTERY:
 - a) Disengage the clamp.
 - b) Disconnect the battery voltage sensor connector.
- (2) for LITHIUM-ION BATTERY:
 - a) Disengage the clamp.
 - b) Disconnect the HV battery connector.

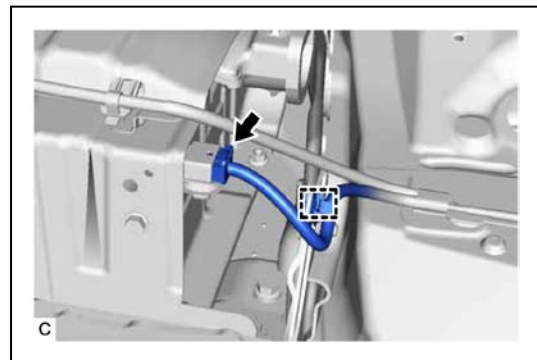
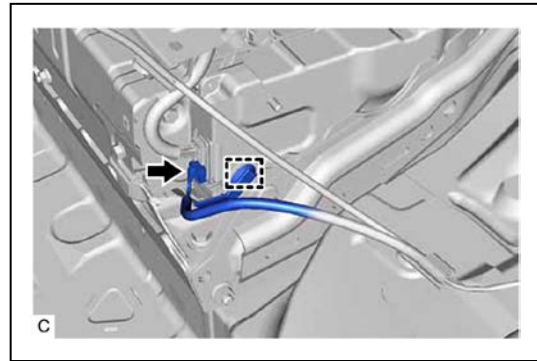

28. REMOVE HV BATTERY

Caution:

Be sure to wear insulated gloves.

(1) Remove the 5 bolts and HV battery from the vehicle body.

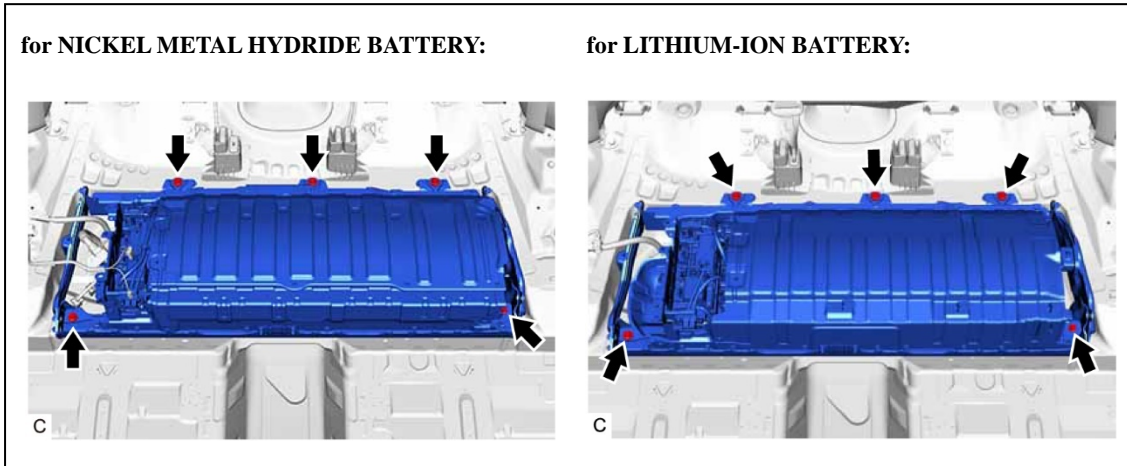

Notice:

- Do not allow foreign matter, such as grease or oil, to adhere to the bolts of the HV battery.
- To prevent the wire harness from being caught, make sure to bundle the wire harness using insulating tape or equivalent.
- Use cardboard or another similar material to protect the HV battery and vehicle body from damage.
- Since the HV battery is very heavy, 2 people are needed to remove it. When removing the HV battery, be careful not to damage the parts around it.
- When removing the HV battery from the vehicle, do not allow it to contact the vehicle.
- When removing/installing/moving the HV battery, make sure not to tilt it more than 80°.
- Insulate the disconnected terminals or connectors with insulating tape.